



FISH PROCESSING LIGHTING

Maritime Applications



LED | LIGHTING CATALOG



ENGINEERED LIGHTING SOLUTIONS

Vision X lighting fixtures are not merely lighting systems, they are engineered lighting solutions. They provide increased efficiency, increased safety, decreased environmental impact, and decreased costs. Vision X LED lights offer a large increase in energy efficiency over older technologies while also increasing the safety and productivity of the working environment by outputting 80% more light than the fixtures used previously.



SOLUTION PROCESS

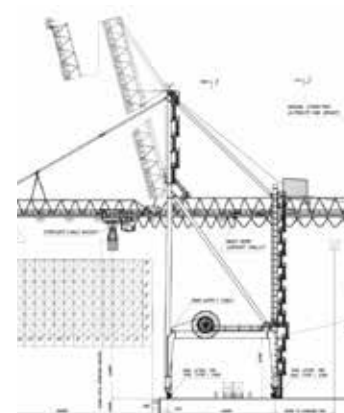

2D BLUEPRINT

Vision X Lighting begins each project with a customer provided list of equipment to be retrofitted, then gathers the technical information for the equipment.



3D MODEL

A 3D model is built to the customer's specifications, then carried over into the rendering.

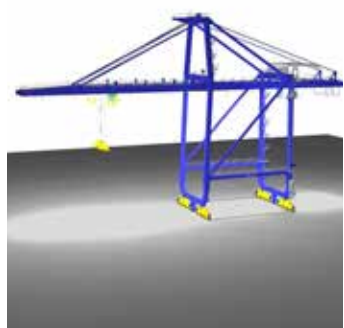

SIMULATION RENDER

A simulation rendering ensures the final product will meet the customer's lighting requirements.

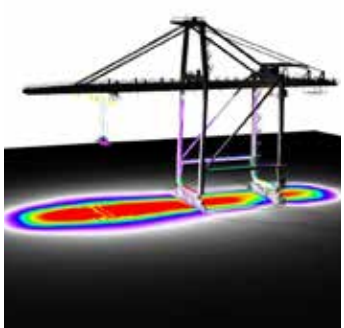

SOLUTION

Vision X Lighting creates a complete breakdown of the customer's specific needs to meet their lighting and safety requirements.



MAST LIGHTING

Product Information

Project Name:
Date:
Type:



SPREADER LIGHTING

Product Information

Project Name:
Date:
Type:

Application

Designed to outshine and outlast the competition, the AC Mast Lighting fixture features advanced electronic technology like Pulse Width Modulation, Electronic Thermal Management, and a Redundant Circuit Design (60 LED) that allow the fixture to function even if half of the light should fail for unknown reasons. This is part of the effort by Vision X to ensure that the AC Boom Lighting fixture is the most dependable LED fixture in the workplace.

Application

Designed to outshine and outlast the competition, the AC Spreader Lighting fixture features advanced electronic technology like Pulse Width Modulation, Electronic Thermal Management, and a Redundant Circuit Design (30 LED) that allow the fixture to function even if half of the light should fail for unknown reasons. This is part of the effort by Vision X to ensure that the AC Spreader Lighting fixture is the most dependable LED fixture in the workplace.

SPECIFICATIONS 280-WATT HIGH LED

Mechanical Information:

Fixture Weight:	37.05 lbs (16.81kg)
Shipping Weight:	40.05 lbs (18.17kg)
Mounting/ Entries: (See Accessories)	(1) 3/4" NPT - TOP (2) 3/4" NPT 90° - SIDES (2) 3/4" NPT 45° - SIDES

Electric Specifications:

Operating Voltage:	90 - 305V AC 127 - 431V DC
Wattage:	280W
Operating Temp:	-40°C ~ 60°C
THD:	<20% (@load≥50% / 115VAC,230VAC) (@load≥75% / 277VAC)
Power Factor:	≥ 0.98/115VAC ≥ 0.95/230VAC ≥ 0.92/277VAC
Short Circuit:	Constant Current Limiting, Recovers Automatically After Fault Condition is Removed
Frequency:	47-63Hz
Vibration:	15.6Grms

Construction:

Housing:	Die-Cast 6061 Aluminum
Finish:	Gloss Grey
Lens:	Polycarbonate Lens

LED Light Engine / Driver

LED:	XP-LHD(CREE)
Amp Draw:	2.43A @ 115VAC 1.22A @ 230VAC 1.01A @ 277VAC
Lifespan:	50,000 hr



PART #:	BEAM PATTERN
1 LSG00660xxSTRHDQC	10°, 25°, 40°, 60°, 90°
LSG02140STRHDQC	180° Ultra Wide Flood

2D DRAWING:

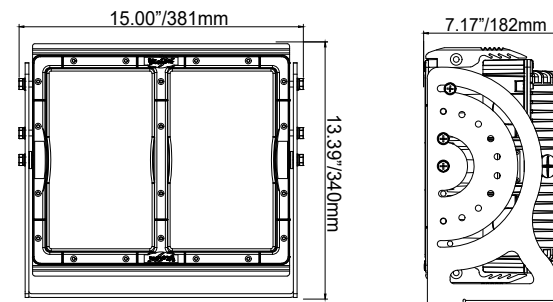

RATINGS:

EMC Emission:	Compliance to EN55015, EN55022 (CISPR22) Class B, EN61000-3-2 Class C (@Load ≥ 50%); EN61000-3-3
EMC Immunity:	Compliance to EN61000-4-2,3,4,5,6,8,11, EN61547, EN55024, Light Industry Level (surge immunity Line-Earth 4KV, Line-Line 2KV)
UL 1598A Marine:	✓
Ingress Protection:	IP-68, IP69k

SPECIFICATIONS 140-WATT HIGH VOLT LED

Mechanical Information:

Fixture Weight:	22.05 lbs (10kg)
Shipping Weight:	26.9 lbs (12.2kg)
Mounting/ Entries: (See Accessories)	(1) 3/4" NPT - TOP (2) 3/4" NPT 90° - SIDES (2) 3/4" NPT 45° - SIDES

Electric Specifications:

Operating Voltage:	90 - 305V AC 127-431V DC
Wattage:	140W
Operating Temp:	-40°C ~ 60°C
THD:	<20% (@load≥50% / 115VAC,230VAC) (@load≥75% / 277VAC)
Power Factor:	≥ 0.98/115VAC ≥ 0.95/230VAC ≥ 0.92/277VAC
Short Circuit:	Constant Current Limiting, Recovers Automatically After Fault Condition is Removed
Frequency:	47-63Hz
Vibration:	15.6Grms

Construction:

Housing:	Die-Cast 6061 Aluminum
Finish:	Gloss Grey
Lens:	Polycarbonate Lens

LED Light Engine / Driver

LED:	XP-L(CREE)
Amp Draw:	1.22A @ 115VAC 0.61A @ 230VAC 0.51A @ 277VAC
Lifespan:	50,000 hr



PART #:	BEAM PATTERN
2 LSG0630xxSTRHDQC	10°, 25°, 40°, 60°, 90°
LSG0270STRHDQC	180° Ultra Wide Flood

2D DRAWING:

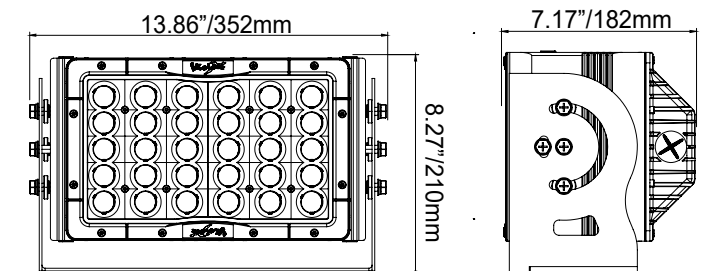

RATINGS:

EMC Emission:	Compliance to EN55015, EN55022 (CISPR22) Class B, EN61000-3-2 Class C (@Load ≥ 50%); EN61000-3-3
EMC Immunity:	Compliance to EN61000-4-2,3,4,5,6,8,11, EN61547, EN55024, Light Industry Level (surge immunity Line-Earth 4KV, Line-Line 2KV)
UL 1598A Marine:	✓
Ingress Protection:	IP-68, IP69k



SPREADER LIGHTING

Product Information

Project Name:
Date:
Type:

Application

Designed to outshine and outlast the competition, the Spreader Lighting fixture features advanced electronic technology like Pulse Width Modulation, Electronic Thermal Management, and a Redundant Circuit Design that allow the fixture to function even if half of the light should fail for unknown reasons. This is part of the effort by Vision X to ensure that the Machine House Lighting fixture is the most dependable LED fixture in the workplace.

Built-In Backup Battery Available



SPECIFICATIONS 50-WATT JUNCTION BOX

Mechanical Information:

Fixture Weight:	8 lbs (3.8kg)
Shipping Weight:	10 lbs (4.5kg)
Mounting/ Entries: (See Accessories)	(6) 3/4" NPT - SIDES

Electric Specifications:

Operating Voltage:	90 - 305VAC 127 - 431VDC
Wattage:	50W
Operating Temp:	-40°C - 60°C
THD:	<20% (@load≥50% / 115VAC,230VAC) (@load≥75% / 277VAC)
Power Factor:	≥ 0.98/115VAC ≥ 0.95/230VAC ≥ 0.92/277VAC
Short Circuit:	Constant Current Limiting, Recovers Automatically After Fault Condition is Removed

Frequency:	47-63Hz
Vibration:	15.6Grms

Construction:

Housing:	Die-Cast 6061 Aluminum
Finish:	Gloss Grey
Lens:	Polycarbonate Lens

LED Light Engine / Driver

LED:	MHB-B(CREE)
Amp Draw:	0.43A @ 115VAC 0.22A @ 230VAC 0.18A @ 277VAC
Lifespan:	50,000 hr

PART #:	BEAM PATTERN
3 LSG0330xxSTRHDQC	10°, 25°, 40°, 60°, 90°
LSG0225180STRHDQC	180° Ultra Wide Flood

2D DRAWING:

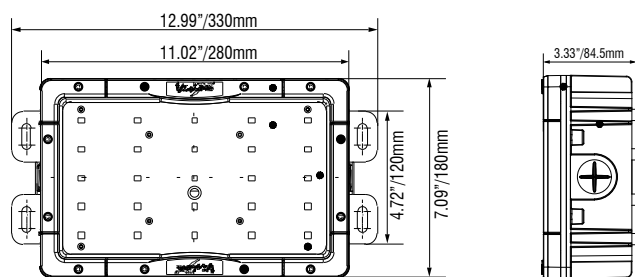

RATINGS:

EMC Emission:	Compliance to EN55022, EN61000-3-2 Class A, EN61000-3-3
EMC Immunity:	Compliance to EN55024, EN61000-4-2,3,4,5,6,8,11; light industry level(surge 2KV), criteria A
UL 1598A Marine:	✓
Ingress Protection:	IP-68, IP69k



CABIN LIGHTING

Product Information

Project Name:
Date:
Type:

Application

Designed to outshine and outlast the competition, the Walkway Lighting fixture features advanced electronic technology like Pulse Width Modulation, Electronic Thermal Management, and a Redundant Circuit Design that allow the fixture to function even if half of the light should fail for unknown reasons. This is part of the effort by Vision X to ensure that the Walkway Lighting fixture is the most dependable LED fixture in the workplace.

SPECIFICATIONS 10-WATT JUNCTION BOX

Mechanical Information:

Fixture Weight:	2 lbs (0.9kg)
Shipping Weight:	4 lbs (1.8kg)
Mounting/ Entries: (See Accessories)	(4) 3/4" NPT - SIDES

Electric Specifications:

Operating Voltage:	90 - 264VAC 127 - 370VDC
Wattage:	10W
Operating Temp:	-40°C - 60°C
THD:	<20% (@load≥50% / 115VAC,230VAC) (@load≥75% / 277VAC)
Power Factor:	≥ 0.98/115VAC ≥ 0.95/230VAC ≥ 0.92/277VAC
Short Circuit:	Constant Current Limiting, Recovers Automatically After Fault Condition is Removed
Frequency:	47-63Hz
Vibration:	15.6Grms

Construction:

Housing:	Die-Cast 6061 Aluminum
Finish:	Gloss Grey
Lens:	Polycarbonate Lens

LED Light Engine / Driver

LED:	5630(LG)
Amp Draw:	0.09A @ 115VAC 0.04A @ 230VAC 0.04A @ 277VAC
Lifespan:	50,000 hr



PART #:	BEAM PATTERN
4 LSGSM40180FQC	180° Ultra Wide Flood

2D DRAWING:

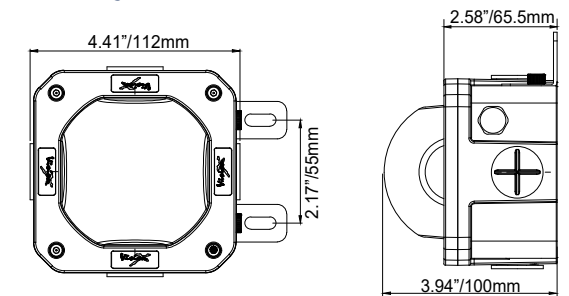

RATINGS:

EMC Emission:	Compliance to EN55022, EN61000-3-2 Class A, EN61000-3-3
EMC Immunity:	Compliance to EN55024, EN61000-4-2,3,4,5,6,8,11; light industry level(surge 2KV), criteria A
UL 1598A Marine:	✓
Ingress Protection:	IP-68, IP69k



VISION X USA
1601 Boundary Blvd
Auburn WA 98001
United States of America
P: 253-218-2900
www.vxstructural.com



VISION X ASIA
23-7 Dongtansandan
9-gil Dongtan-myeon Hwaseong-si
Gyeonggi-do 18487, Korea
P: 82-32-515-4814
www.visionxlighting.com